

Article number: 20343232M1080KS
Description: E+G Levelling foot
GN 343.2-32-M10-80-KS
Note: 0

Measures

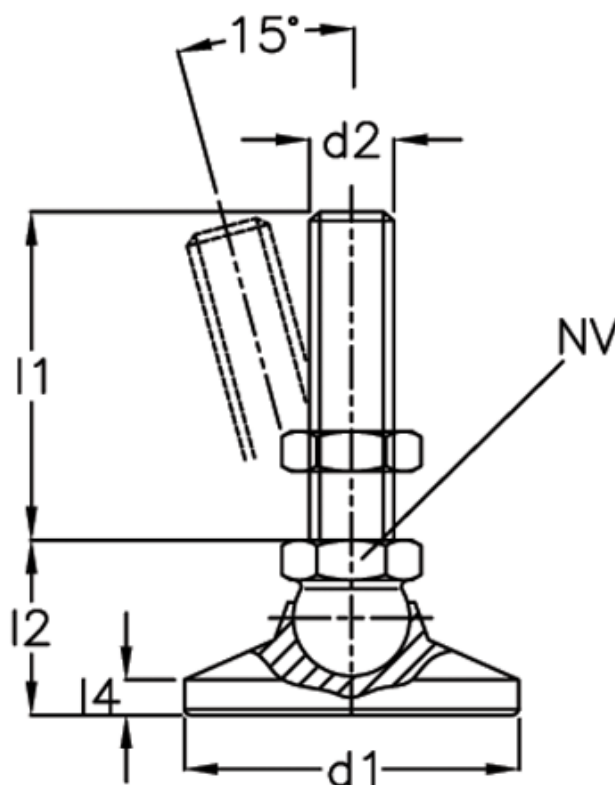

d1 = 32
d2 = M10
l1 = 80
l2 = -
l3 = 24.5
l4 = -
l5 = 6.5
NV = 15

Static load = 23
Weight in (g) = 120